

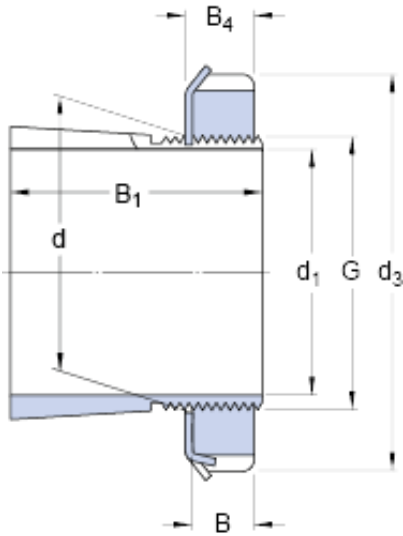

LP BEARING CORP.



skf SNW 115x2.1/2 Adapter sleeves, inch dimensions

Bearing No. SNW 115x2.1/2

d ₁	63.5 mm
d	75 mm
d ₃ max.	98.552 mm
B ₁	78.08 mm
B	15.342 mm
B ₄	16.916 mm
G	74.498 mm
Threads per inch	12
Mass adapter sleeve assembly	1.35 kg
Sleeve	S 115x2.1/2
Lock nut	AN 15
Lock washer	W 15
Hydraulic nut	HMVC 15E

SNW 115x2.1/2 Bearing 2D drawings and 3D CAD models